

Drive Components: Storage, Installation, Maintenance and Troubleshooting Handbook



▶ Storage	3	▶ Isoran, Silver, Gold and Platinum Belt	20
▶ Storage conditions	3	▶ Rubber and PU Open End Belt Installation	21
▶ Storage and Packaging	4	▶ Linear and Omega motion	21
▶ V-Belts	4	▶ Vertical systems	22
▶ Poly-V, Rubber and PU Endless Belts	6	▶ Tension check	23
▶ Rubber and PU Sleeves	7	▶ Final check	24
▶ Megapower Belts	7	▶ Tension Control	25
▶ Joined and Megaflex Belts	8	▶ Installation Checklist	25
▶ Open End Belts	8		
▶ Special Belts	9		
▶ Other Mechanical Components	10		
		▶ Maintenance	26
▶ Primary Installation	11	▶ Before the Maintenance Operations	27
▶ Pulley Installation	11	▶ Maintenance Procedure	27
▶ Belt Installation	13	▶ Simple Inspections	28
▶ Belt Identification	13	▶ Deep Inspections	30
▶ Belt Branding	13		
▶ V-Belt Installation	14	▶ Inspections Frequency	31
▶ PolyV in Rubber and in PU Installation	16		
▶ Rigid Belts	16	▶ Troubleshooting	32
▶ Elastic Belts	17	▶ V-Belts	32
		▶ PU Timing Belts	34
▶ Endless or Joined Belts Installation	19	▶ Rubber Timing Belts	37
▶ Megaflex for Power transmission and Megapower	19	▶ General Problems	39
▶ Megaflex and Megalinear Joined for conveyor transmission	20	▶ Pulleys	40

The aim of this handbook is to give the necessary information to preserve in the best way the belts condition during all their lifetime, starting from the first storage till the working operation. All the considerations and suggestions are based on the experience accrued by Megadyne in decades of product development.

Storage

Proper storage condition of transmission components are the first step for good performances and a longer lifetime. In case of improper storage conditions the components could be immediately damaged, even before being assembled in the final system.

Storage conditions

The conditions of storage are similar for all belts and basically involves the environmental aspect of the warehouse.

The belts must be stored:

- In environmental temperature, between 5°C and 30°C. Different temperatures, in particular higher, can cause damage to the belt, due to the deformation of the superficial structure. These effects can lead to reduced belt performance, in particular the belt could swell and not run straight and smooth. Lower temperatures are tolerated but not suggested, they can cause an increasing of the stiffness of the belt, in this case it is necessary to heat the belt up till 20°C before operation.
- Keep away from equipment generating ozone, like high voltage electrical machines or fluorescent light sources. Also combustion gases and vapors, that can cause ozone, should be avoided. These conditions are referred in particular to rubber products, while PU does not suffer the same problems.

- Store in a dry place. The humidity must be maximum of 50%. PU and Rubber have hygroscopic properties, so they have the proclivity to absorb water particles. This absorption can cause a deterioration of the compound, internal tensions and, in case of steel cord, the beginning of oxidation. Storage in excessively high humidity conditions has proven to reduce the belt life.
- Proper protective packaging. The packaging delivered by Megadyne is designed to provide the best solution to protect the components from external environmental agents, not only water but accidental contact with grease, oil or other chemical components that could compromise the functionality of the drive.
- Avoid direct contact with sun light. Excessive sun light (UV) can cause deterioration of the compound, in particular with PU belt.

Storage and Packaging

Storage procedures are significantly different depending on the kind of belt, in the following paragraph you can find solutions suggested by Megadyne.

V-Belts

In order to store correctly the V-Belt, it is advisable to hang them on “saddles” or on large diameter tubular brackets. This diameter should be at least ten times the height of belt cross section. Long belts can be stacked to save space, provided that they are correctly coiled (see Figure n.1).

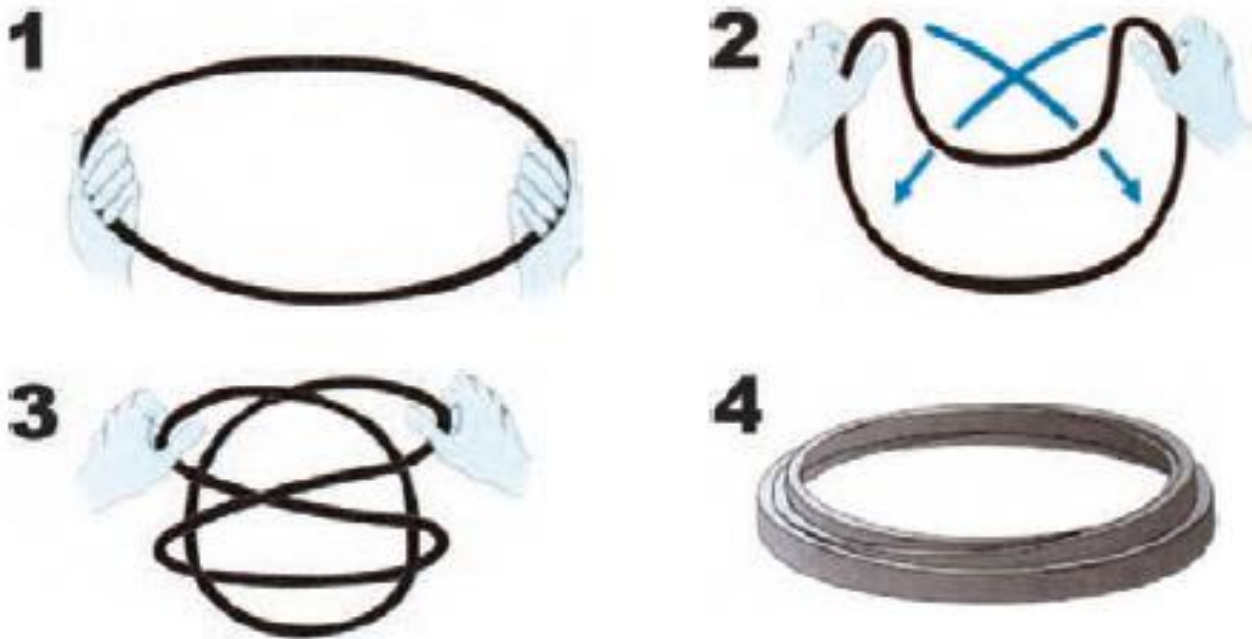

Figure 1

Short belts can be stored on shelves, but be aware that stacks should not be more than 300 mm high, as the bottom belts may be otherwise deformed. Finally, hooks and nails are unsuitable for suspending the belts.

In Table 1 it is possible to find the maximum number of coilings for V-Belt produced by Megadyne.



Maximum Number of Coilings of V-Belts for Storage

Belt Cross Section	Belt Length (Inches)	Number of Coils*	Number of Loops
Oleostatic: Z, A, B Gold Label Cog Belt: AX, BX SP:SPZ, SPA, SPB 19 Linea-X: XPZ, XPA, XPB Kompattex: 3V Power Wedge: 3VX, 5VX XDV2: 38, 48, 58 Esaflex: AA Varisect: 13x6, 17x5	Under 60 60 up to 120 120 up to 180 180 and Over	0 1 2 3	1 3 5 7
Oleostatic: C, 20, 25 Gold Label Cog Belt: CX SP:SPC Linea-X: XPC Kompattex: 5V Power Wedge: 5VX Esaflex: BB Varisect: 21x6,5, 22x8	Under 75 75 up to 144 144 up to 240 240 and Over	0 1 2 3	1 3 5 7
Oleostatic: D, 45 Esaflex: CC Varisect: 42x13, 47x13, 52x16, 55x16, 65x20, 70x20	Under 120 120 up to 240 240 up to 330 330 up to 420 420 and Over	0 1 2 3 4	1 3 5 7 9
Oleostatic: E, 50 Kompattex: 8V Power Wedge: 8VX Varisect: 42X13, 47X13, 52X16, 55X16, 65X20, 70X20	Under 180 180 up to 270 270 up to 390 390 up to 480 Over 480	0 1 2 3 4	1 3 5 7 9
* One coiling results in three loops, two coilings result in five loops, etc.			

Table 1

Poly-V, Rubber and PU Endless Belts

Rubber and PU Sleeves

This category contains all the belts produced by mold injection still in sleeves (Megapower, PolyV in PU, PolyV in rubber, Isoran, Silver, Gold and Platinum). The full sleeves must be conserved together (as shown in Figure 2). The sleeves can be nested one inside the other. The number of sleeves packed can change according to the dimensions and the force necessary to pack. Please do not exceed the number because the compression could cause damage to the cord or crimping of the belts. Please do not store them in a nylon bag, but allow a continuous air circulation.

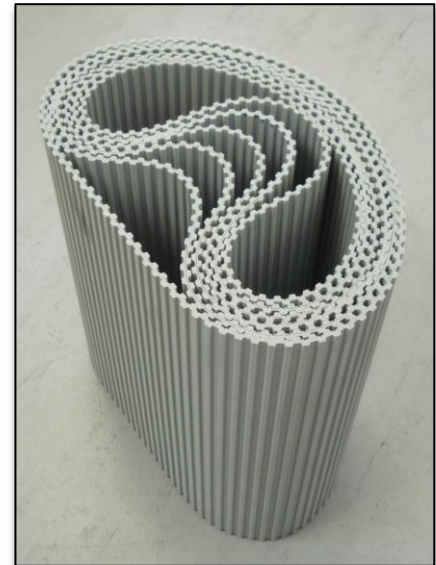

Figure 2



Figure 3

Megapower Belts

The storage condition of these belts depend on the finished dimension:

- Length < 300 mm and width < 10 mm: the belts have to be packed untied in a nylon bag (Figure n.3) and stored in closed shelves.

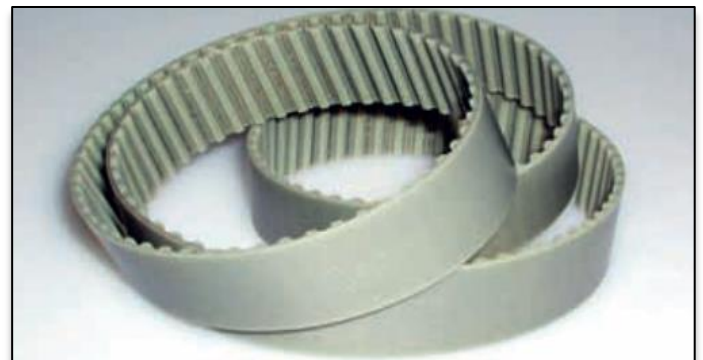

Figure 4

- Length > 300 mm and width > 10 mm: the belts have to be packed one inside the other and covered by a protective cellophane layer.

Joined and Megaflex Belts

If possible, these belts should be set one inside the other but in all cases they must be protected by a cellophane layer (Figure 5).

If the belts are going to work in a set, they must be kept always together inside the protective layer till the final assembly. This has to be done to prevent damage and trouble that can compromise correct synchronization and functionality (Figure 6).

Open End Belts

The mode of storage can change according to the pitch and the width of the considered belt:

- Pitch ≤ 6 mm and width ≤ 15 mm: the belts must be conserved in carton boxes and sealed with a transparent cellophane layer (Figure 7).



Figure 5



Figure 6



Figure 7

- Pitch > 6 mm and width > 15 mm: the belts must be covered just with a nylon layer (Figure 8).

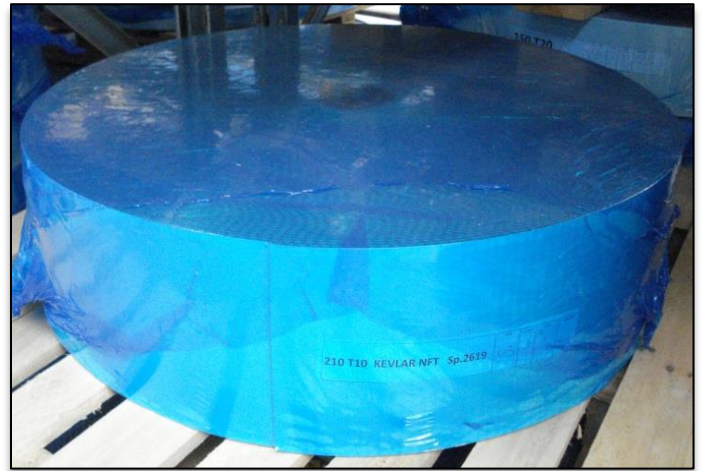

Figure 8

Special Belts

In case of special reworking, like top covers or cleats (Figure n.9), it is necessary to evaluate, case by case, the minimum diameter of the internal roll and the correct storage of the belts to avoid excessive tensions on the cords. Also in this case the belt should be protected with a cellophane layer.

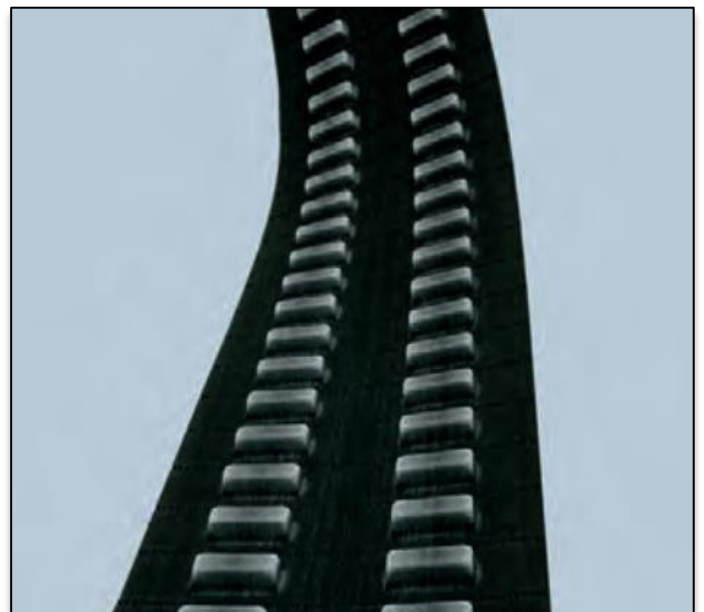

Figure 9

Other mechanical components

Other mechanical components commonly involved in belt transmission are the pulleys and the clamping plates (Figure n.10).

The main enemies of these components are obviously rust and impacts. Both of these aspects can be kept under control with proper storage conditions.

If the components have not been reworked with superficial treatments (like chroming, anodized coating, burnishing...) it is better to cover them with a layer of antioxidant material. Please be careful because at the moment of the assembly this liquid must be removed in order to avoid undesirable chemical reactions with the belt.



Figure 10

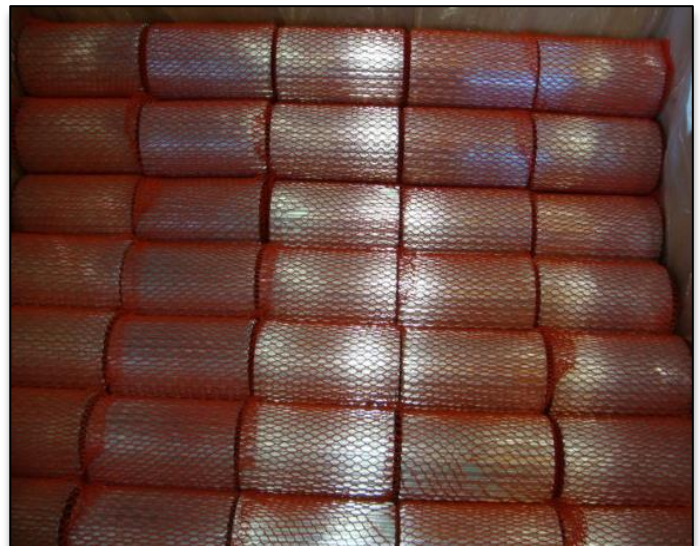

Figure 11

Regarding accidental deformations, these can be avoided using care during storage operations and handling. If possible always keep the fragile surfaces protected with a Pluriball sheet or protective net (Figure n.11).

Primary Installation

During installation there is a high risk to damage the component. The eventual damage may be undetectable but could produce a negative effect in the performances of the belt. For these reasons Megadyne SPA recommends to handle carefully the components and follow the instructions suggested.

Pulley Installation

The installation starts with the pulley positioning. During this process the main target is to avoid misalignment of the components. The pictures refer to V-belt pulleys but the process is the same for timing pulleys.

Alignment should be given preliminary consideration at this time, before assembly please check and make sure that the shafts of the driver pulley and the shafts of the driven pulleys are parallel.

The pulleys have to be properly mounted and as near to the bearings as practical. The position can be easily configured by laser (Figure n.12) or by straight line (Figure n.13)



Figure 12

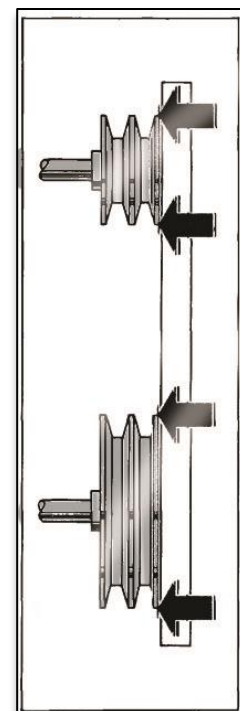

Figure 13

In case you want to proceed with the laser, please set the two tools on the same side of the two pulleys and, acting on the fixing screws, adjust the position of the two pulleys until you find the correct position.

It is possible to do the same operation with a straight edge just placing it on the surface of the first pulley and acting on the second one.

For correct system function and to increase belt life, proper pulley installation is necessary: pulleys must be parallel. If pulleys are not parallel the belt could fail and cause damage to the equipment.

To assure correct operation, α and Δx must be as small as possible (Figure 14) and summarized in Table 2.

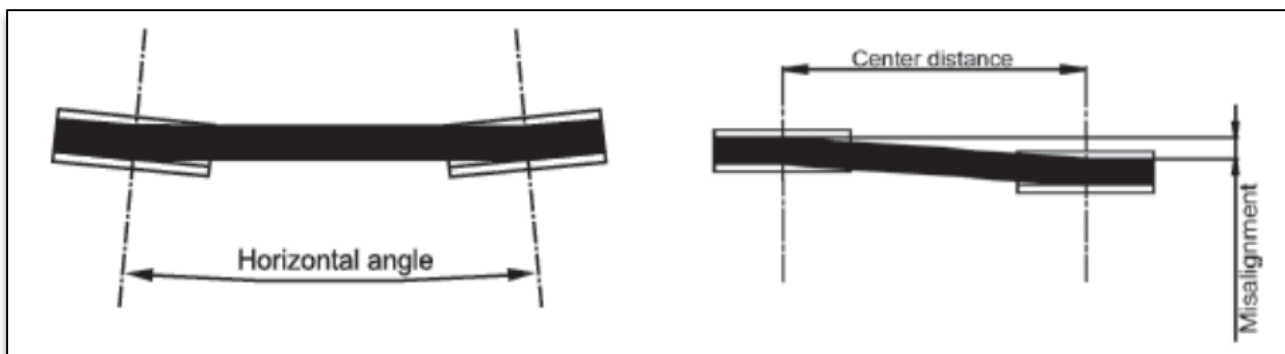

Figure 14

Kind of belt	Max Horizontal Angle [°]	Misalignment
PolyV with PV pulleys	2	3 mm/m
PolyV with flat pulleys	1	15 mm
Joined belt	$\alpha = \arctg \cdot \frac{\Delta a_{max} *}{b_w}$	$\Delta < P_w - b_w$
Megaflex		
Megapower		
Rubber timing belts		

* Δa_{max} : Difference between the centerdistance measured on the two sides of the same pulley

b_w : Belt width

P_w : Pulley width

Table 2

After installation of the pulleys if necessary proceed with a through inspection of the surfaces. The aim of this check is to find out eventual damages on the pulleys caused during the installation procedure and avoid the presence of residual flash that can damage the belt surface immediately after the belt installation.

Belts Installation

The installation process is different for V-belt, toothed belts and poly-V. Due to the different properties of such belts the procedures can easily change and specific drive design catalog installation procedures for each type should be followed.

It can be said that for all the types of belts, excessive force should not be used during installation as it will result in belt deformation and/or brakage of the tensile cord (the load carrying the element of all belts).

When possible always decrease center distance to the maximum permissible position to ensure belts will easily go over pulleys.

Belt Identification

The first step of installation is identifying the right profile, pitch and the material of the belt to use. This will allow to avoid all the misunderstanding and accidental failures.

To be sure of the belts features and dimensions, please check and compare them with the dimensions written in Megadyne catalogues.

Belt Branding

In general, on the belt surface it is possible to find out the branding that allows to recognize the main features and eventual properties of the component.

The following table (Table 3) shows the general way to recognize the belts features.

Kind of belt	Branding	Family Name	Belt Section Code	Length	Pitch/Profile	Width	Notes
V-Belt	Oleostatic A 52	Oleostatic	A	52 Inches			
Rubber Open End	RPP5M 20				RPP5	20 mm	
Silver	1400 SLV 14M 55	SLV		1400 mm	14M	55 mm	
Gold	1400 GLD 14M 55	GLD		1400 mm	14M	55 mm	
Platinum	1400 PLT 14M 55	PLT		1400 mm	14M	55 mm	
PolyV	1200 J8			1200 mm	J	8 ribs	
Megaflex	MPW+50+AT10+10000+Special manufactures	MPW		10000 mm	AT10	50 mm	Special manufacturers: special/cord/special compound/extra coating
Megalinear Joined	J+50+AT10+10000+Special manufactures	J		10000 mm	AT10	50 mm	Special manufacturers: special/cord/special compound/extra coating
Megapower	MPW+50+AT10+1500+Special manufactures	MPW		1500 mm	AT10	50 mm	Special manufacturers: special/cord/special compound/extra coating

Table 3

The rolls of PU belt open end are not branded, they can be branded just if agreed with the final customer.

V-Belt Installation

The installation of the V-Belt must be done according to the following few steps:

- Reduce the center distance, this operation has the aim to simplify the operation of belt setting on the grooves;
- Do not force the belt in position using metallic or cutting tools that could damage the rubber surfaces;
- The positioning of the belt must be correct, so it lies in the corresponding grooves of the two pulleys (Figure 15);
- If the belt is not assembled in the correct way the drive will probably be not able to run or at least will work just for a very short time;

- Increase the center distance in order to set up the pre-tensioning force. The correct belt installation tension is given by:

$$T_s = 500 \cdot \frac{2.5 - C_\alpha}{C_\alpha} \cdot \frac{P_c}{Q \cdot v} + m \cdot v^2$$

Symbol	Unit	Definition
C_α		Arc correction factor
M	Kg/m	Belt linear mass
P_c	kW	Corrected power
Q		Number of belts
T_s	N/strand	Static tension
V	m/s	Peripheral belt speed
A	°	Arc of contact

Arc correction factor:

α [°]	180	174	169	163	157	151	145	139	133	127	120	113	106	99	91	83
C_α	1.00	0.98	0.97	0.94	0.93	0.91	0.89	0.87	0.87	0.85	0.82	0.80	0.77	0.73	0.70	0.65

- Operate the drive for few minutes to seat the belts in the sheave grooves. Observe the behavior of the transmission in the highest load conditions (usually at the starting, with low speed but high torque). A slight bowing of the slack side of the drive indicates an increase in tension is needed. If the slack side is stretched during the peak load it means that the tension is too high. In case of slippage it is absolutely necessary to increase the pretension of the belt;
- Check the tension several times during the first 24 hours of installation, taking care of the slack side span;
- Keep the drive free of debris or foreign materials that may cause slippage between belt and pulley or damage to the surfaces in contact;

Poly-V in Rubber and in PU Installation

The PolyV are divided in two categories, elastic and rigid, so the mounting procedure will not be the same for both. The installation method does not depend on the compound material.

The installation process has to start with a first check of the correct dimensions of belt and pulleys. The number of grooves on the pulleys must be equal or superior to the number of ribs on the belt.

Rigid Belts

During installation the belt should never be forced over the pulleys edges. To correctly install the belt it is necessary to reduce the center distance, then it is possible to fit the belt without any tension. The required allowance to move on the axis is determined in Table 5 and Figure 15

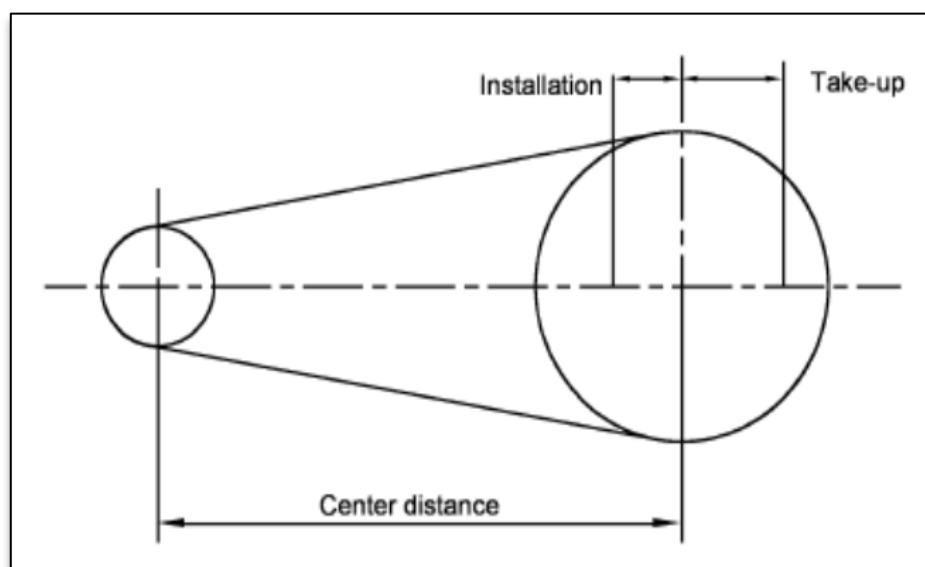

Figure 15

Belt Length [mm]	Installation [mm]				Take up [mm]
	PH, PTB2 & PJ	PK	PL	PM	
<750	9	11			13
751-1000	10	12	25		16
1001-1250	12	12	25		20
1251-1500	14	16	25		20
1501-1750	16	16	25		25
1751-2000	18	16	25		25
2001-2250	20	23	25		30
2251-2600	22	23	25	40	30
2601-3000		23	30	40	35
3001-4000		23	30	45	45
4001-5000			35	45	55
5001-6000			35	50	65
6001-7500				55	85
7501-9000				60	100
9001-10500				65	115
10501-12000				75	130
12001-13500				80	150
13501-15000				90	165

Table 5

To calculate the exact pretension you can consider the same formulas and the same procedures used in the V-Belt calculation.

Elastic Belt

With elastic belt it is not necessary to reduce the center distance or to remove the pulleys. As the belts have been manufactured to work on a fixed center distance it is necessary just to wrap progressively the belt on the driver and driven pulleys to get the final assembly (Figure 16).



Figure 16

The tension is regulated automatically and depends on the characteristics of the belt. At the beginning it is higher but there is a progressive adaptation (Graphic 1).

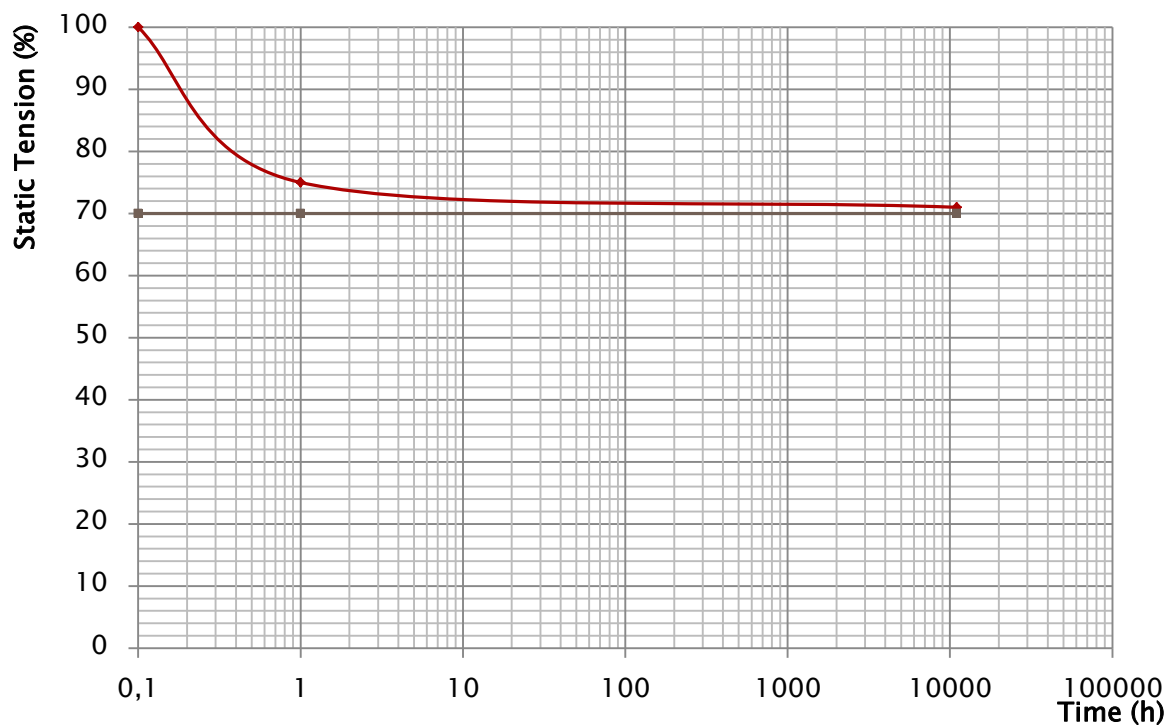

Graphic 1

Under normal conditions, static tension decays rapidly (in a few minutes). After this initial drop the static tension will stabilize. Please note that the tension decay is fairly high (30% - 40% from the initial static load).

Endless or Joined Belts Installation

The endless and the joined belts can be considered similar from the installation point of view. The first suggestion for such configurations is to use in any case flanged pulleys to keep the belt in the right position during the working period (Figure 17).

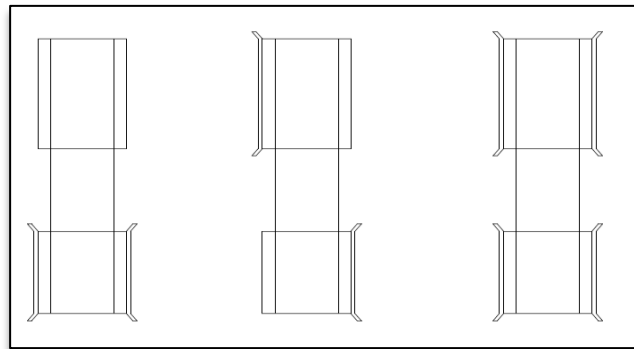

Figure 17

To install the belt it is necessary to reduce the center distance between the pulleys. Then it will be possible to set the belt in the correct position.

The pretension can be calculated using the following rules:

Megaflex for power transmission and Megapower (Figure 18)

$$F_p = 2 \cdot F_v \cdot \cos \beta$$

If the number of the belt teeth is smaller than 60 the pretension will be:

$$F_v = \frac{1}{3} \cdot F_u$$

If the number of the belt teeth is included from 60 to 150 the pretension will be:

$$F_v = \frac{1}{2} \cdot F_u$$

If the number of the belt teeth is bigger than 150 the pretension will be:

$$F_v = \frac{2}{3} \cdot F_u$$

Where F_u is the force transmitted

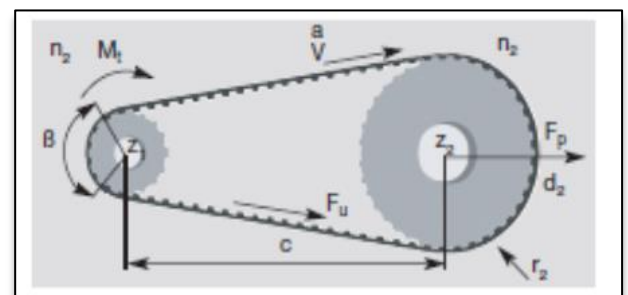

Figure 18

Megaflex and Megalinear joined for conveyor transmission (Figure 19)

In this case the speed ratio is 1:1 (the dimensions of the driver and the driven pulleys are the same).

The value of pretension will be for Megaflex:

$$F_p = 2 \cdot F_v$$

Where F_v is:

$$F_v = \frac{1}{2} \cdot F_u$$

The value of pretension will be for Megalinear:

$$F_p = F_u$$

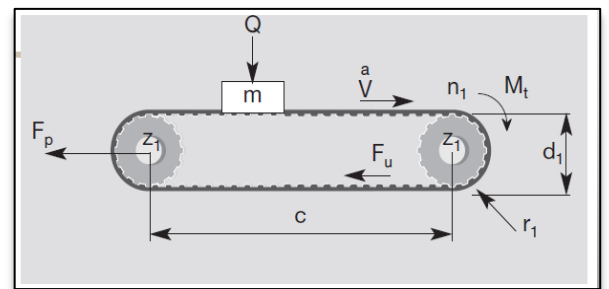

Figure 19

Isoran RPP, Silver, Gold and Platinum Belt

The static tension should be calculated as:

$$T_s = \frac{500 \cdot P \cdot K_m}{v} + m \cdot v^2$$

Symbol	Unit	Definition
T_s	N	Static tension
P	kW	Motor power
K_m		Class of motor factor
v	m/s	Belt linear speed
m	kg/m	Belt mass per unit length

K _m		
CLASS A	CLASS B	CLASS C
1,35	1,5	1,75

In some applications, involving in particular rubber belts with special tolerances, the center distance is fixed, so the evaluation of the pretension from the final customer is not necessary.

Due to the problems and difficulties that these kind of applications can cause, it is necessary to contact the Megadyne SPA Technical office to develop/design the drive jointly from the beginning of the project.

Rubber and PU Open End Belt Installation

The applications involving the open end belts, in rubber or in polyurethane, are so numerous that it is almost impossible to cover all the ways to install them. Moreover in general, also clamping plates and special fixing tools are involved in the assembly.

As usual, the preliminary operation consists of checking the pulley condition and the choice of the correct profile of the belt.

Here are resumed the three most common application realized with the open end rolls:

Linear and Omega Motions

In this case (Figure 20 and Figure 21), to mount the belt it is necessary a reduction of the center distance between the pulleys to facilitate the mounting procedure. Then it is possible to proceed to the assembly of the belt on the clamping plates or directly on the linear unit. It is important to point out that the suggested number of teeth in mesh on the clamp for linear movement can change due to the dimension of the belt, the load to transmit and the profile (the data is contained in the proper catalogue).

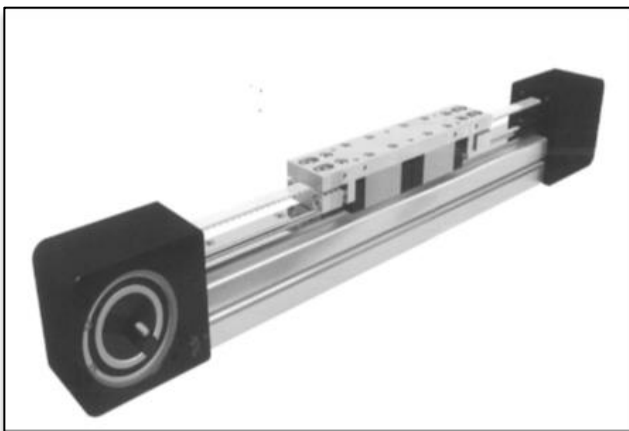

Figure 20



Figure 21

The clamping plates must be fixed with screws and the final assembly must not damage the belt surface. Holes and screws can cause cracks and compromise the performance and the life of the belt.

After this operation it will be possible to regulate the pretension. The proper values can be, in general, calculated as follows:

- Polyurethane and Rubber drives, Horizontal and Omega:

$$F_p = 2 \cdot F_u$$

$$F_u = m \cdot g \cdot \mu + m \cdot a$$

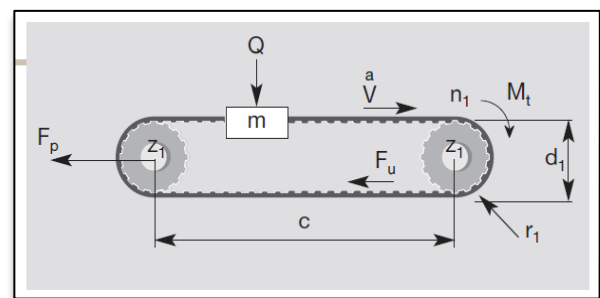

Figure 22

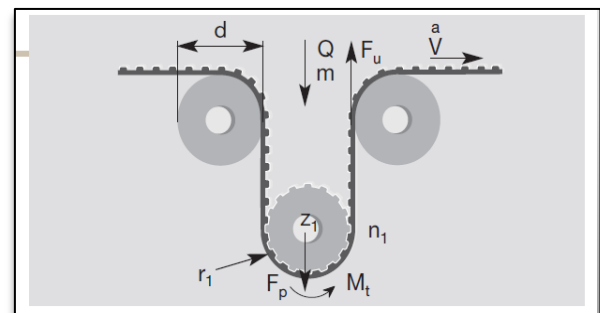

Figure 23

Vertical Systems

Also in this case the recommendations about the assembly and the clamping plates are the same as before.

Furthermore, due to the layout of the application, sometimes it is not necessary (and possible) to adjust and check the pretension. It is possible just in case of closed lifting systems or in vertical Omega, like in the Figure 23.

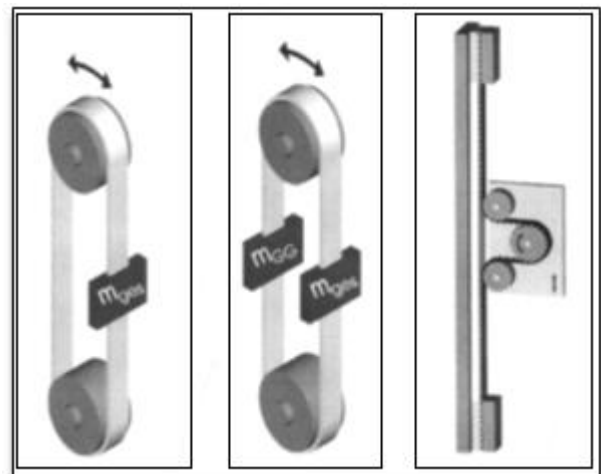

Figure 24

In all the three cases it is possible to consider a pretension force of:

$$F_p = 1 \div 1.2 \cdot F_u$$

Where F_u is the higher force verifiable during the lifting and lowering operations. Due to the technical nature of these applications it is strongly suggested to entrust the calculation of the pretension values to the Megadyne SPA technical office.

Tension Check

As was briefly mentioned in the V-Belt installation paragraph, after the tensioning operation, it is necessary to check the correct pretension value. This evaluation can be done in a simple way using the vibration method.

The procedure to measure the tension of the belt can be completed using a Belt Tension Gauge (Figure 25). The device consists of a small sensing head which is held across the belt to be measured. The belt is then tapped to induce the vibration at its natural frequency. The vibrations are detected and the frequency of vibration is then displayed on the measuring unit.

The relation between belt static tension (F_p) and the frequency of vibration (f) may be calculated using the following formula:

$$f = \frac{1}{2 \cdot t} \cdot \sqrt{\frac{F_p}{m}} \quad \text{or} \quad F_p = 4 \cdot m \cdot t^2 \cdot f^2$$

Symbol	Unit	Definition
F_p	N	Static tension
m	kg/m	Belt mass per unit length
f	Hz	Frequency of vibration
t	m	Free belt span length



Figure 25

Final Check

After the positioning of the belts and pulleys it is necessary to recheck again the set-up of the drive. In particular it is necessary to control the positions of the pulleys because, during the belt assembly, they could have been moved or misaligned.

If possible move by hand, and check the correct movement of the drive. The reduced speed allows a last inspection of the conditions of the belt and the correct assembly.

Before testing the belt in the operative conditions it is necessary to install all the guards and protection systems.

When the assembly operations are finished it is possible to start up the drive. Megadyne suggests a gradual increase of the speed and performance of the belt to allow a general view of the behavior of the system (relative to vibration and noises) and to permit to the belt an auto adjustment on the drive.

In case of excessive noise or vibration it could be necessary to change the settings of the belt, reducing or increasing the pretension values. If, even after several adjustments, the problems remain, contact Megadyne.

Tension Control

It is necessary to implement a tension control after a certain working period. Due to the huge number of different applications it is impossible to give a general rule.

The period between the installation and the tension check must be maximum two weeks synchronous (toothed) belts, while for the V-Belt it is necessary to evaluate the tension several times in the first 24 hours. If the application has high speed, in particular for synchronous belts, the re-tension has to be done earlier than two weeks.

Installation Checklist

- Handle all the components carefully;
- Inspect all the drive elements and clean them;
- Mount the pulleys;
- Check the pulley alignment;
- Reduce the center distance (if possible, according to the application);
- Select the proper belt;
- Position the belt in the correct way (if necessary installing the clamping plates and all the other mechanical supports) without forcing;
- Pretension the belt;
- Re-inspect the drive components;
- Check the pulley alignment;
- Rotate the drive to check for eventual problems;
- Install all guards and protective systems;
- Start up the drive gradually (looking and listening to the behavior of the drive components) increasing the drive speed;
- Re-tension the belt;

Maintenance

Improper drive maintenance is the primary cause of drive problems, immediately followed by improper installation. The sum of these two factors account for more than the 50% of general transmission troubles (Figure 27).

Considering that installation and maintenance are operations strictly linked together, it is easy to understand the importance of these two operations.

A proper maintenance program, with scheduled timetables, allows a relatively trouble free run for a long period.

It has two main advantages:

- Reduce the costs, with a proper and not invasive inspections is possible to keep under constant control the conditions of the belt, avoiding long stop periods, and the consecutive loss of money and production delays;
- Reduce the risk of sudden failures, that can cause damages, not only to the goods transported or to the system, but also the people working close to the transmission;

The procedure of maintenance are strictly connected to the features of the application, so it is not possible to create an unique rule. Megadyne can just summarize the most important points of a general procedure.

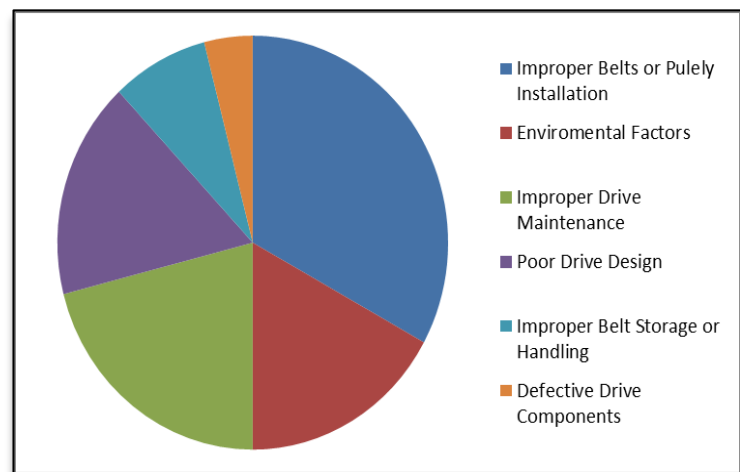

Figure 27

Before Maintenance Operations

In order to avoid risks for the health always follow these few preliminary rules:

- Wear proper clothing and use proper safety devices before working on the machine;
- Make sure that the power and the energy source, connected to the drive, are completely off;
- Make sure that nobody can activate the power while the operator is inspecting or maintaining the drive;
- Place all the machine components in a neutral position. Avoid to leave them in a not perfect balance. It will prevent risks of falls with consequential damages to the employees and to the tools;



Maintenance Procedures

The procedures illustrated here are valid for all belts. The first step in maintenance procedures must be the cleaning of the drive system and, in general, of all the inspection and working area.

Cleaning is strongly suggested to increase also the speed of the maintenance operations and to find much more quickly and easily eventual problems of the transmission. Furthermore the presence of debris:

- On the guard, debris can cause an obstruction to cooling and ventilation. The accumulation of material can increase belt temperature and cause overheating which will destroy the belt;

- On the pulleys and belts can change the working position and reduce the lifetime of the system;

The maintenance program should be organized in simple and superficial inspections alternating with more through inspections.

Simple Inspections

In the simple inspections it is not necessary to disassemble all the system and, in general, they do not take much time. First of all, it is strongly suggested to check the noise and the vibrations of the belt while it is still working. A well designed drive, if correctly maintained, should operate smoothly and quietly.

The main checks in the simple inspections are only visual and superficial. The aim is to verify the conditions of the drive and eventual signs of a future failure. In order to proceed in this direction it is necessary to disassemble the guards and the protections.

With the transmission stopped it is necessary to check the superficial conditions of all the mechanical components, in particular it is recommended to observe:

- Belt teeth, inspect for the presence of cracks at the base of teeth or excessive wear;
- Belt cord, inspect for cord coming out between the belt teeth, cord damaged, rust;
- Belt back, inspect for cracks present or cord coming out;
- Pulley teeth, inspect for rust or excessive wear;
- Clamping plates, inspect for rust;

- Belt surfaces. Check the surfaces in case of damage due to high temperature. Please note that the maximum running temperatures for Megadyne belts are contained in Table 5;

	Tmax [°C]	Tmin [°C]
Isoran	85	-25
Silver	85	-25
Gold	85	-25
Platinum	115	-35
Megapower	80	-25
Megaflex	80	-25
Megalinear	80	-25
PolyV Elastic Rubber	85	-25
PolyV Elastic PU	80	-25
PolyV Rigid Rubber	85	-25
PolyV Rigid PU	80	-25
Oleostatic	80	-30
Gold Label Cog belt	90	-30
SP	80	-30
Linea X	90	-30
Compattex	80	-30
Power Wedge	90	-30
Varisect	90	-30
Esaflex	80	-30
XDV 2	80	-20
Pluriband	80	-30

Table 5

In particular all the declaration released by Megadyne are referred to 20°C, out of this temperature the conditions are not ideal and the lifetime forecast changes. In case of similar signs Megadyne SPA strongly recommend to change immediately the damaged item with a new one. It is necessary to reduce as much as possible the contact between oil or grease and the belt. Please pay attention because an over-lubricated system can cause a loss of lubricating material that, if in direct contact with the belt, may cause swelling and distortion. After the visual check it is suggested a tension control; as usual the tension is checkable with the vibration method (already discussed at page 22).

Deep Inspections

In this kind of inspection Megadyne SPA recommends following the same procedures of the simple inspections, as well as the following:

- Verify the eventual vibrations or noise of the belt still mounted;
- Disassemble the guard and the safety systems;
- Reduce the center distance and remove the belt, in this way it will be possible to operate a deeper check on the working side of belt and pulleys;
- Clean all the components (Figure 27);
- Observe the status of the system looking for worn sidewalls (Figure 28), damaged sides (Figure 29), shiny groove bottom (Figure 30). If there are signs similar to the ones represented on the three previous figures or visible damage to the belt, please proceed immediately to the substitution of the component following the procedure exposed in the previous chapter of this handbook;

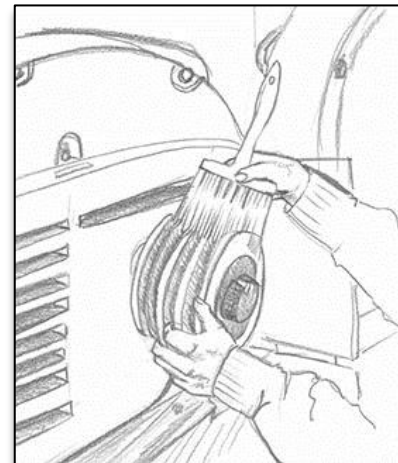

Figure 27

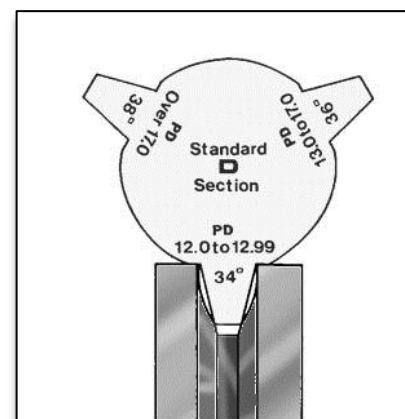

Figure 28

- If it is not necessary to replace any components please proceed with the check of the alignment of the pulleys;
- Install the belt;
- Increase the center distance to get the right pretension;
- Measure and verify the pretension with the methods already covered in this handbook;
- Check the alignment of the pulleys and shafts;
- Rotate drive by hand, if possible, to check the correct setting of the belt;
- Install the safety system;
- Run a test increasing the speed slowly to check the behavior of the system, taking care also of eventual new vibrations or excessive noise;
- Check the tension as recommended in the installation chapter;

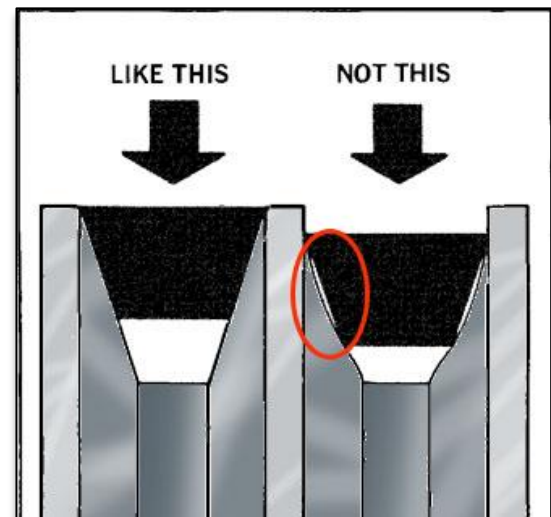

Figure 29

Inspection Frequency

The inspections are influenced not only by the features of the transmission, but also by external parameter like the operative environment, the production cycles, the temperature conditions, the layout and accessibility of the drive.

In the greater part of the situations, the decision about the frequency of the inspections has to be taken on the experience of the maintenance employees.

It is possible to resume Megadyne SPA partial suggestions as follow:

- Critical drives; with high speed, heavy loads, frequent start and stop and critical temperatures frequent inspections are required. The quick inspections have to be done every one or two weeks, while the deep inspections have to be done every three months;
- Normal drives; a well dimensioned transmission should be quickly checked once a month, while a deep inspection should be run every six months;

Troubleshooting

To ensure that the performances and durability of a synchronous belt drive will fully meet the requirements of particular applications, it is necessary to first accurately select the drive, and then to make sure the drive is correctly installed. If this procedure is not followed, the drive life and efficiency may be considerably reduced. The most frequent problems encountered, together with their probable causes, are listed in the table below. We hope that this will serve as a useful quick-reference guide, but if the drive problems persist or if they are not identified in the following list consult Megadyne.

V-BELTS	
Rapid V-Belt wear V-BELTS	
Rubbing belt guard	Check guard clearance
Shave misalignment	Correct the shave alignment
Worn or damaged sheave grooves	Check and replace the shaves
Wrong belt cross section or type	Check dimensions and replace the belt
Sheave diameter too small	Use larger diameter shave
Improper V-belt installation	Replace the belt (do not pry belts)
Overload drive	Reduce load
Belts improperly stored	Use new set of V-Belts
Mismatched belts	Replace with matched set
Replacing one belt	Replace the complete set
V-belt slipping	Increase the tension





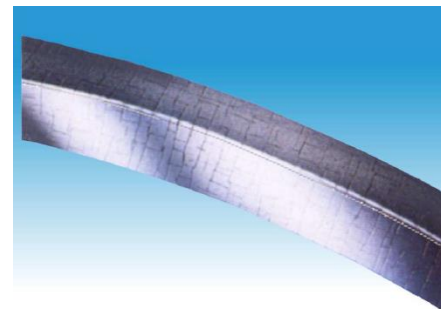
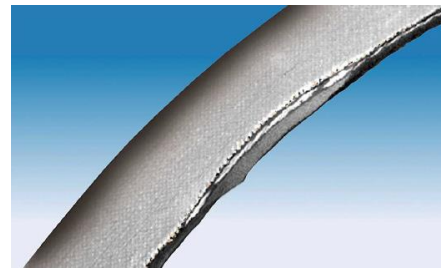

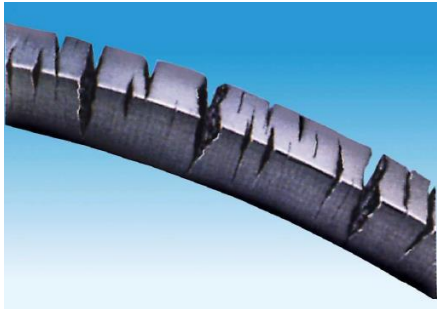
V-BELTS	
V-Belt turned over in sheave groove	
Broken cords in V-Belt, belt pried over shaves	Determine how belt was installed
Overload drive	Reduce loads
Defective cord construction in V-Belt	Check for narrow spot in belt, replace the belt
Impulse load	Use banded V-Belts or spring-loaded idlers
V-Belt slippage	
Lack of tension	Increase the tension
Overloaded drive	Reduce loads
Sheave worn, belt bottoming in groove	Replace sheave
Sheave grooves too wide, belt bottoming in grooves	Use belt with larger cross section or replace shaves
Oily drive conditions	Correct the unnecessary oil or grease condition

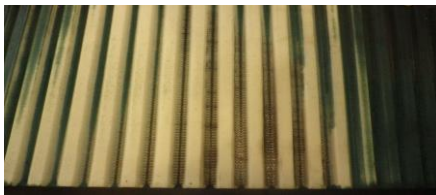

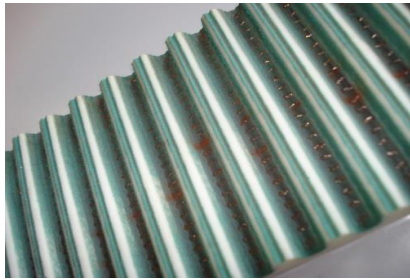
V-BELTS	
V-Belt squeal	
Lack of tension	Increase the tension
Overloaded drive	Reduce loads
Insufficient arc of contact	Increase the center distance between the
Cracked V-Belts	
Belt slippage	Increase the belt tension
Excessive heat	Provide adequate ventilation and check the belt tension
	
Repeated V-Belt fracture	
Shock load	Increase V-Belt tension, heavier drive
Heavy starting loads	Increase V-Belt tension, heavier drive may be required
Improper V-belt installation, belt pried over sheaves	Determine how belt was installed, replace
V-Belt tensile break	
Shock load	Redesign the drive
Improper belt handling or storage	Store in original package, do not crimp
Forcing belt onto drive during installation	Do not pry the belt over sprockets
Debris or foreign object in the drive	Remove debris and check the guard

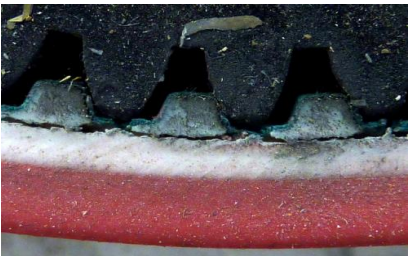
POLYURETHANE TIMING BELTS	
Abnormal wear of the belt on the side of the teeth	
Belt excessively taut	Reduce the center distance
Excessive overloading	Use a wider belt
Incorrect contour or diameter of pulley	Replace pulley after checking contour or diameter
	
Abnormal wear of the NFT	
Belt excessively taut	Reduce the center distance
Excessive overloading	Use a wider belt
Incorrect contour or diameter of pulley	Replace pulley after checking contour or diameter
	

POLYURETHANE TIMING BELTS		
Abnormal wear of the belt on the bottom of the tooth		
Excessive overloading	Use a wider belt	
Abnormal wear of the belt at the tooth root		
Incorrect contour or diameter of pulley	Replace pulley after checking contour or diameter	
Abnormal wear of the belt on the side		
Incorrect contour or diameter of pulley	Replace the pulley after checking contour or diameter	
Misalignment or wrong setting of pulleys	Replace the pulley after checking contour or diameter	
Oscillation of the axes and/or of the bearings	Correct the positioning of the pulleys and reinforce the bearings	
Flanges bent	Straighten the flanges	
Laceration of the teeth		
Number of teeth in mesh less than the minimum	Increase the number of teeth in mesh or use the belts and pulleys of smaller pitch	
Excessive load	Use a wider belt	
Rupture of the tension member		
Excessive load	Use a wider belt	
Diameter of the pulley below the minimum	Increase the diameter of the pulleys	

POLYURETHANE TIMING BELTS	
Breaks or cracks in the top surface	
Exposure to excessive low temperatures	Eliminate the low temperature or use a different compound
Rupture of the joined area	
Excessive tension	Reduce the tension
Abnormal elongation of the joined area	
Excessive tension	Reduce the tension
Oxidation of the tension member	
High humidity	Use stainless steel cord
Belt overriding the flanges	
Faulty installation of the flanges	Reinstall the flanges correctly
Misalignment of pulleys	Align pulleys
Wrong pretension	Reset the tension

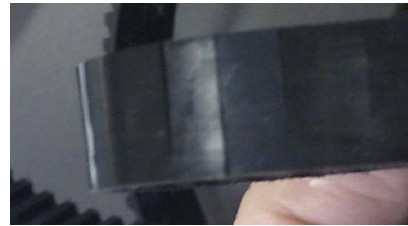



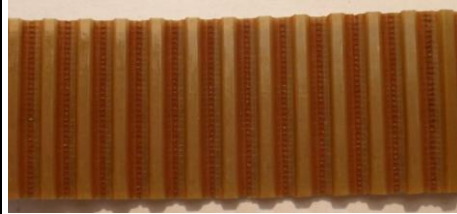





POLYURETHANE TIMING BELTS	
Failure through traction or through laceration of the teeth, indicating corrosion of the tension member	
Diameter of small pulley i.e. below the minimum	Increase the diameter of the pulleys or use belts and pulleys of smaller pitch
Excessive moisture	Eliminate the moisture
Softening and melting of the top surface of the belt	
Excessive high temperature or excessive oli presence	Eliminate the high temperature or reduce the amount of oil presence

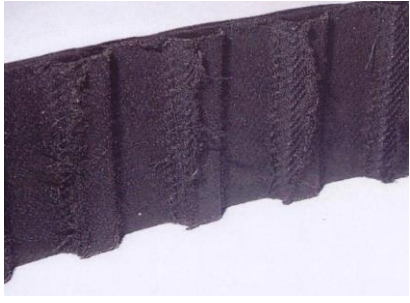



TIMING BELTS IN RUBBER	
Crimp failure	
Mishandling	Avoid the improper storage of the belts
Inadequate belt installation tension	Increase the tension of the belt
Small pulley diameter	Increase the diameter of the pulleys
Debris or foreign object in the drive	Remove debris and check the guard

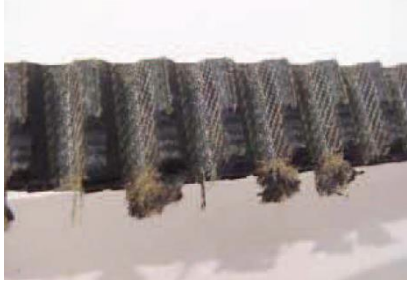

TIMING BELTS IN RUBBER		
Tooth root cracks		
Shock load	Redesign the drive	
Laceration of the teeth		
Shock load	Redesign the drive	
Abnormal abrasion of the teeth		
Belt excessively taut	Reduce the center distance	
Excessive overloading	Use a wider belt	
Incorrect contour or diameter of pulley	Replace pulley after checking contour or diameter	
Abnormal wear of the belt at the tooth root		
High belt land pressure	Reduce the pretension of the belt	
Abnormal wear of the belt on the side of the teeth		
Low belt installation tension	Increase the tension	

TIMING BELTS IN RUBBER		
Teeth separation		
Excessive tensioning	Reduce the tension	
Belt edge wear		
Pulley misalignment	Check and set the pulleys alignment	
Cracking from high temperature		
Excessive temperature	Reduce the temperature or change the compound of the belt	

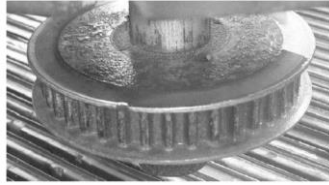
GENERAL PROBLEMS	
Drive excessively noisy	
Pulleys out of line	Align the pulleys
Excessive installation tension	Reduce the center distance
Excessive load	Use a wider belt
Diameter of the pulley below the minimum	Increase the pulley diameter
Apparent elongation of the belt	
Reduction of center distance due to the bearings not being	Restore the initial center distance and

PULLEYS		
Not homogeneous wearing of the pulley		
Misalignment of the axes	Set the alignment	
Oxidation of the pulley surface		
Excessive humidity	Change the material of the pulley or use a special superficial treatment	
Excessive wear of pulley teeth		
Excessive overloading	Use a wider belt	
Belt excessively taut	Reduce the center distance	
Pulley material insufficiently hard	Harden the pulley surface	